

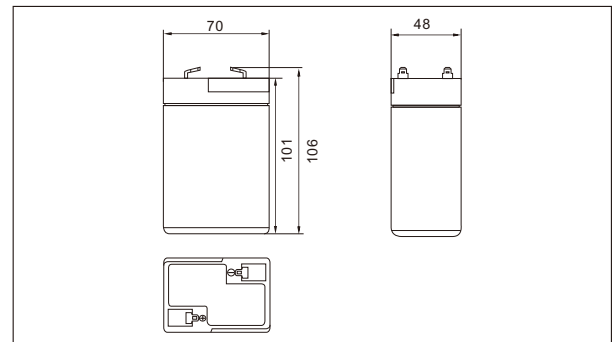

SW640(6V4.0AH)



● Outer dimensions (mm)



● Specifications

Nominal Voltage	6 V	
Rated capacity (20 hour rate)	4.0 Ah	
Dimensions	Total Height	106 mm(4.17 inches)
	Height	101 mm(3.98 inches)
	Length	70 mm(2.76 inches)
	Width	48 mm(1.89 inches)
Weight Approx	0.67 Kg(1.47 lbs)	

● Terminal Type (mm)

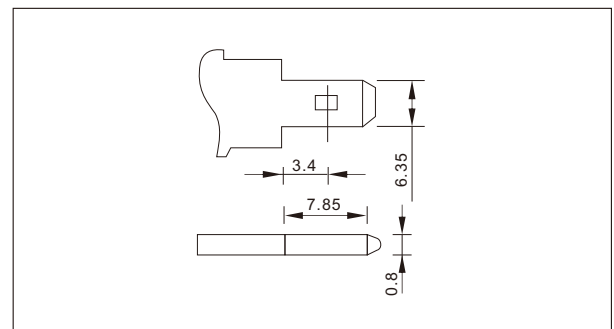

● Characteristics

Capacity 25°C(77°F)	20 hour rate(0.20A)	4.00 AH
	10 hour rate(0.37A)	3.70 AH
	5 hour rate(0.68A)	3.40 AH
	1 hour rate(2.40A)	2.40 AH
	1.5 hour discharge to 5.25 V	1.6 A
Internal Resistance	Full charged Battery at 25°C(77°F)	25 mΩ
Capacity affected by Temperature (20hour rate)	40°C(104°F)	102%
	25°C(77°F)	100%
	0°C(32°F)	85%
	-15°C(5°F)	65%
Self-Discharge at 25°C(77°F)	Capacity after 3 month storage	91%
	Capacity after 6 month storage	82%
	Capacity after 12 month storage	64%
Terminal	T1	
Charge (constant Voltage)	Cycle	Initial Charging Current less than 1.6A Voltage 7.05-7.20 V
	Float	Voltage 6.75-6.90 V

● Discharge Curves 25°C(77°F)

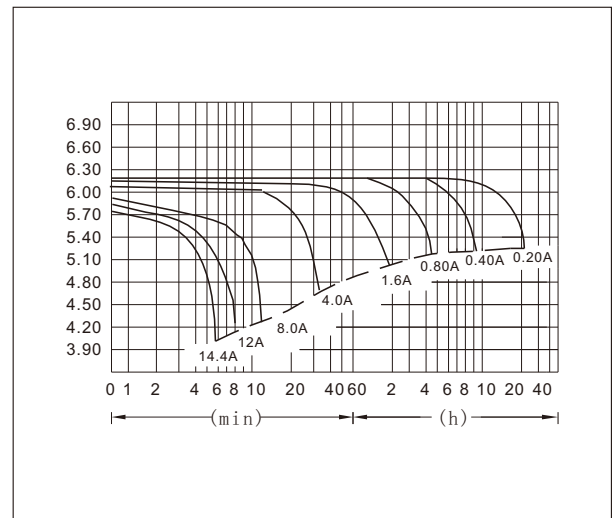

Time		5min	10min	15min	30min	1h	2h	3h	4h	5h	8h	10h	20h
4.80V	A	14.40	9.02	7.00	4.60	2.40	1.40	1.03	0.83	0.70	0.46	0.38	0.21
	W	84.9	53.3	40.3	24.4	13.8	8.1	5.96	4.78	4.06	2.68	2.19	1.20
5.10V	A	13.20	8.83	6.43	4.37	2.25	1.34	1.00	0.80	0.69	0.46	3.72	0.20
	W	79.9	52.5	37.9	24.3	13.0	7.8	5.79	4.63	3.98	2.63	2.15	1.17
5.25V	A	12.24	8.44	6.00	4.23	2.18	1.32	0.98	0.76	0.69	0.45	0.37	0.20
	W	77.2	49.0	36.3	24.0	12.6	7.6	5.69	4.40	3.96	2.61	2.13	1.16
5.40V	A	11.15	8.07	5.60	4.04	2.11	1.28	0.97	0.75	0.65	0.44	0.36	0.20
	W	73.7	47.5	34.9	23.9	12.3	7.5	5.63	4.35	3.78	2.50	2.08	1.13
5.55V	A	9.64	7.60	5.20	3.76	2.03	1.25	0.92	0.73	0.62	0.43	0.35	0.19
	W	57.4	45.9	33.3	23.8	12.1	7.4	5.46	4.33	3.70	2.42	2.04	1.13